

1

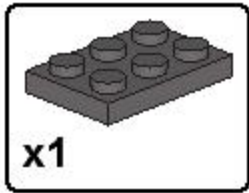

2

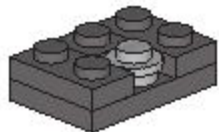
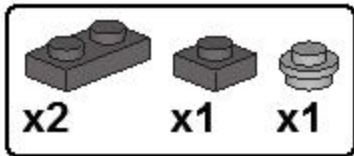

3

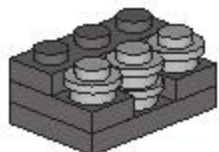
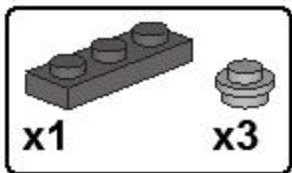

4

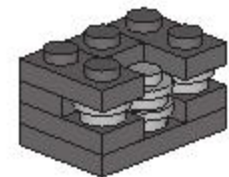
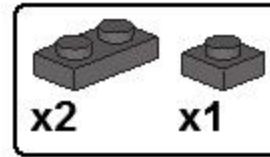

5

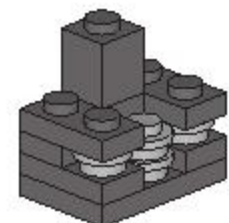
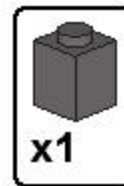

6

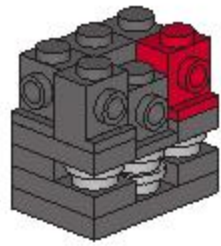

8

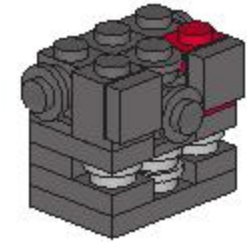
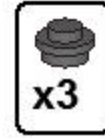

7

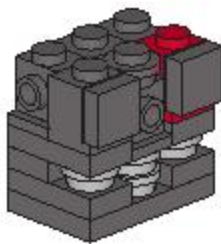
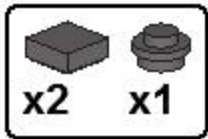

9

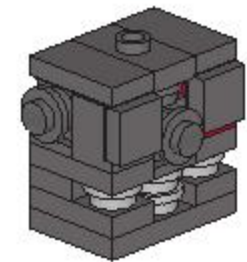
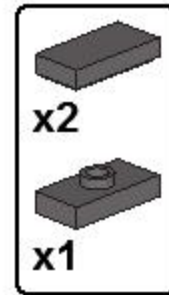

10

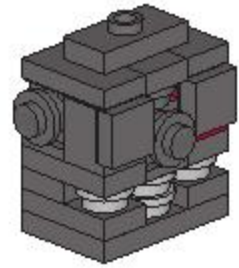
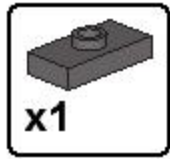

1

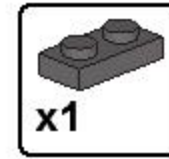

2

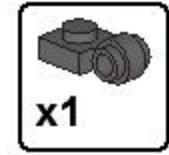

11

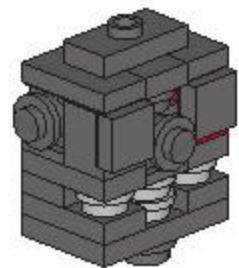

3

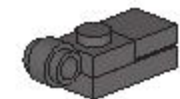
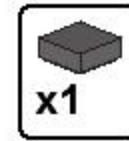

4

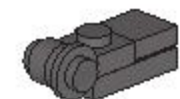
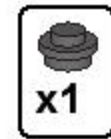

1

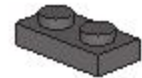
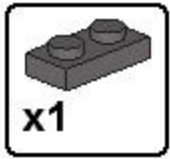

2

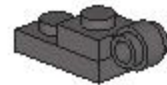
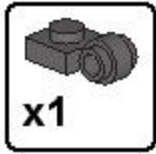

3

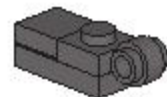
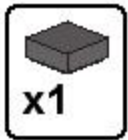

4

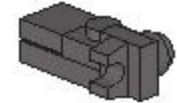
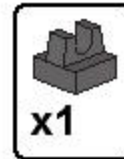

5

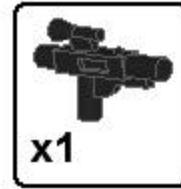

6



1

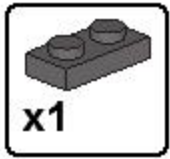

x1

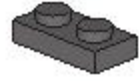

1

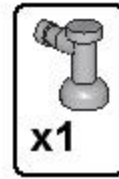

x1



2

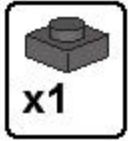

x1

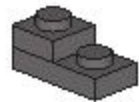

2

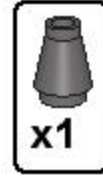

x1

3

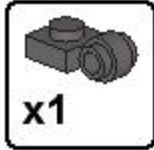

x1

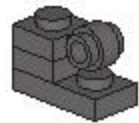

3

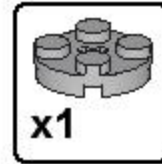

x1



4

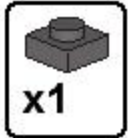

x1

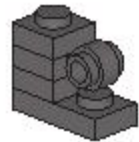

4

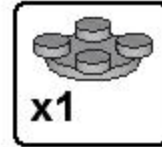

x1



5

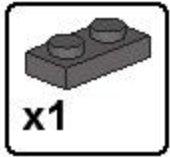

x1



2x

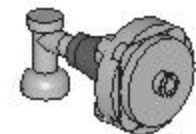

1

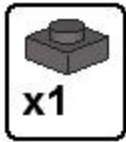

2

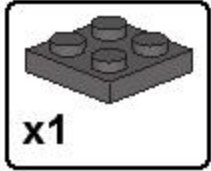

3

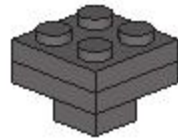
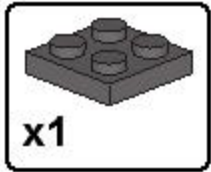

4

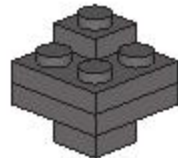
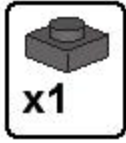

5

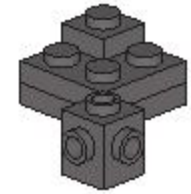
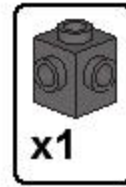

6

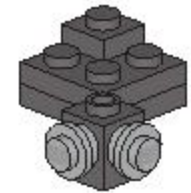

7

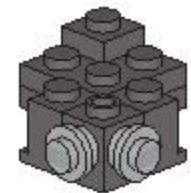
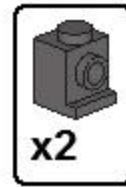

8

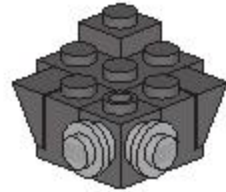

11

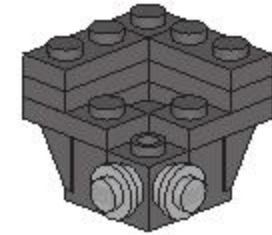
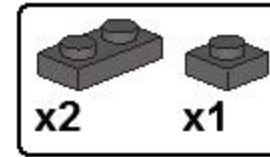

9

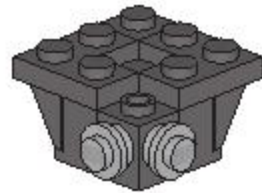
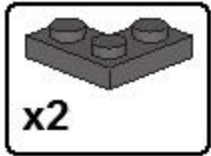

12

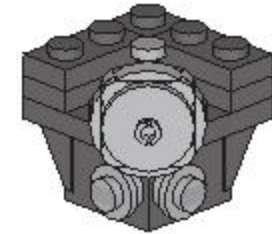
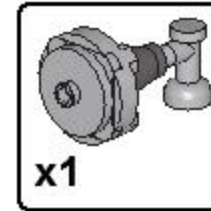

10

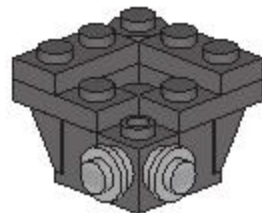
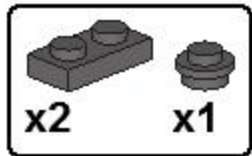

13

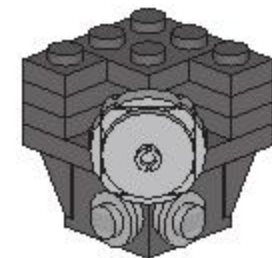
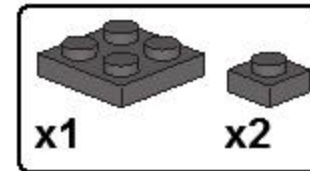



14

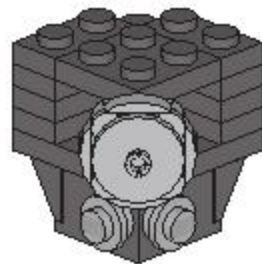
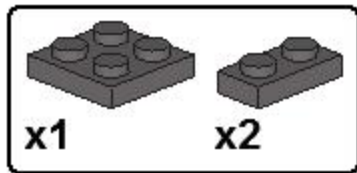

16

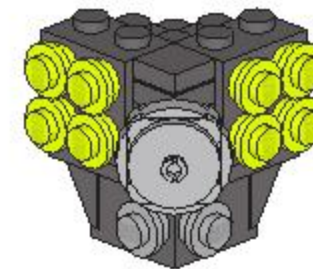

15

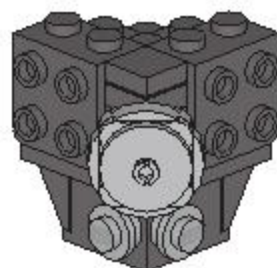
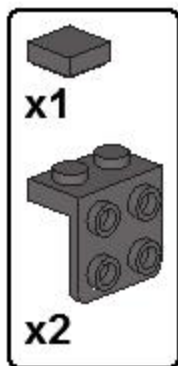

17

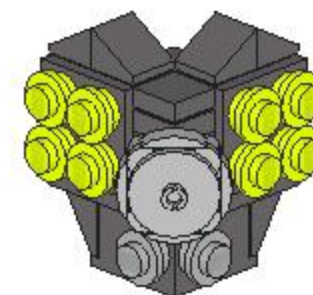

1

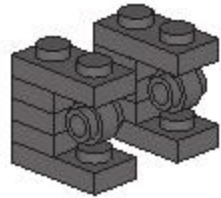
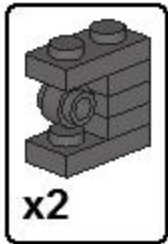

2

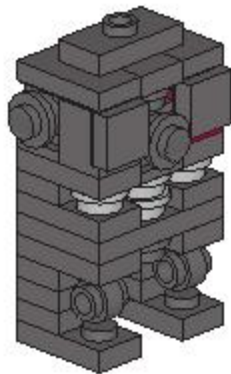
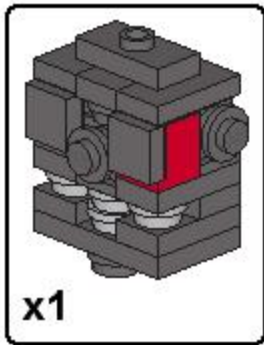

3

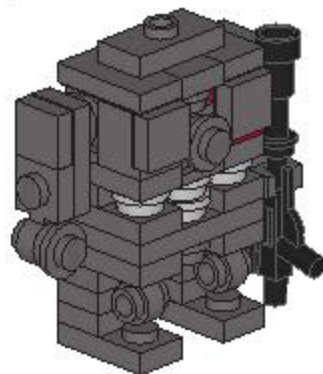
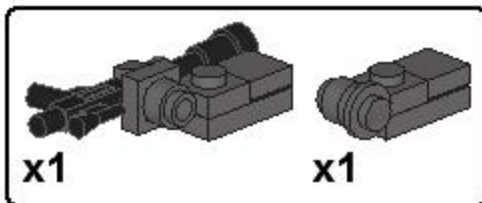

4

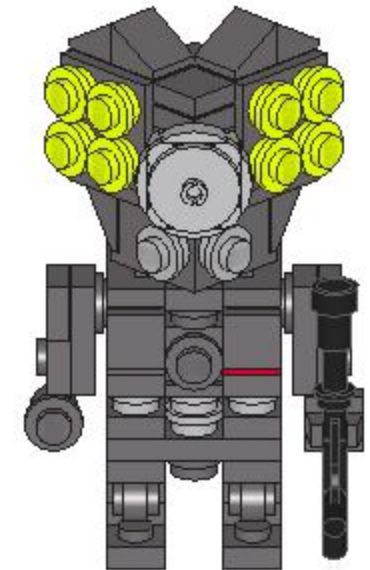
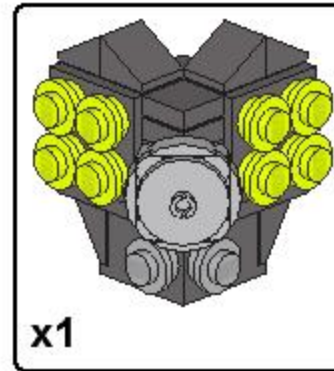

5

