

1

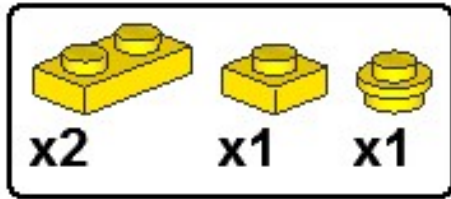

2

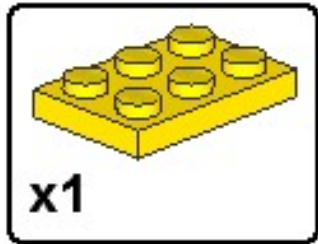

3

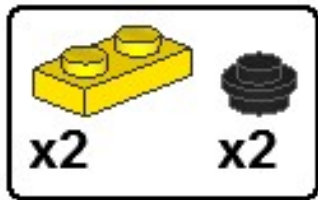

4



5

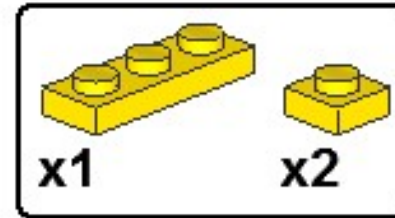

6

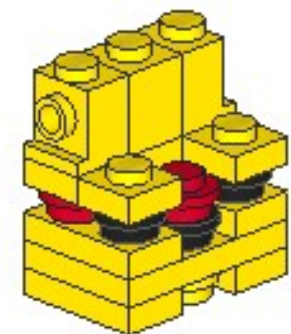
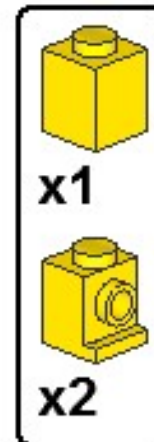

7

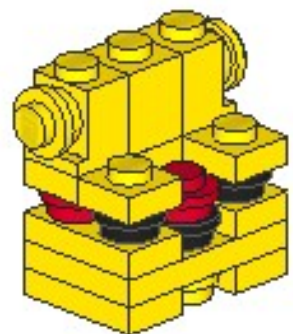

10

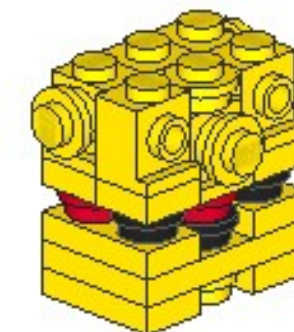
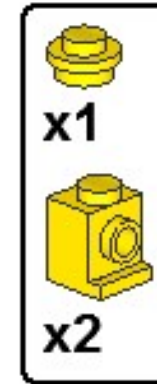

8

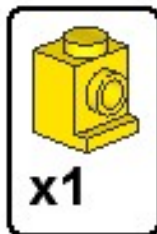

11

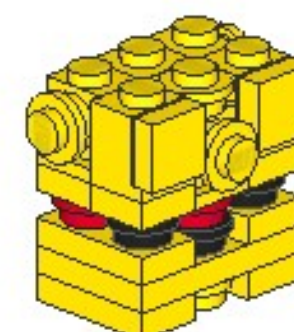
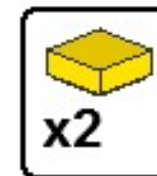

9

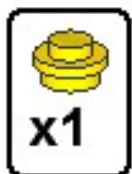

12

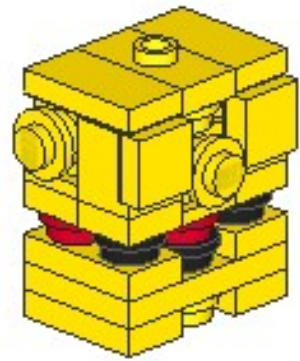
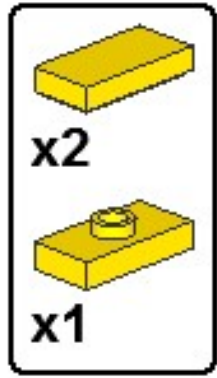

13

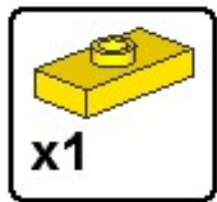

1

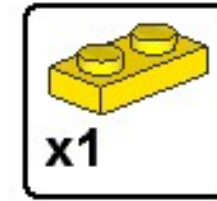

2

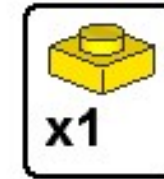

3

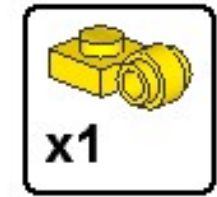

4

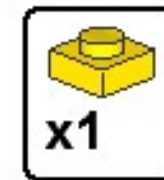

2x

1

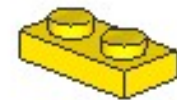
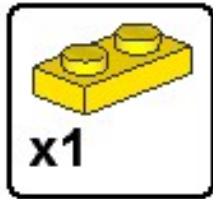

1

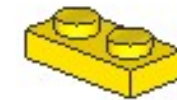
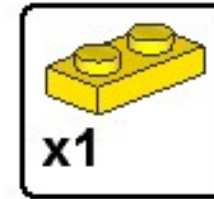

2



2

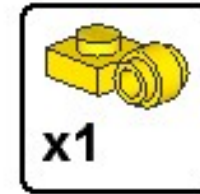

3

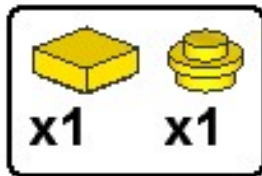

3

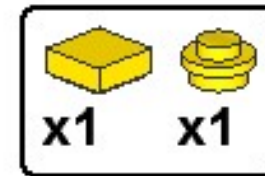

1

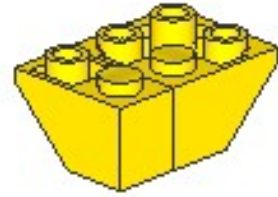
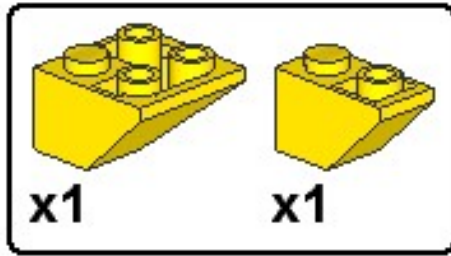

2

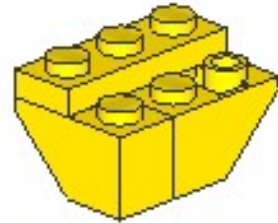
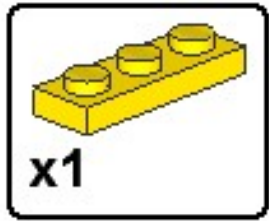

3

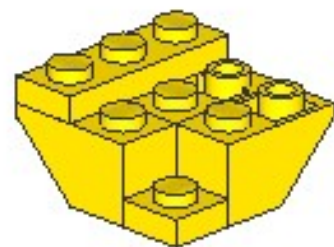
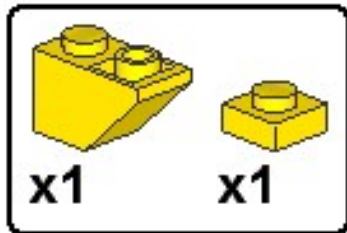

4

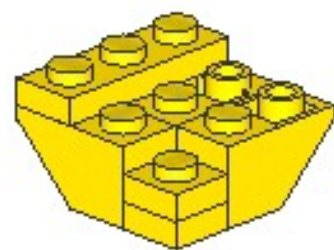
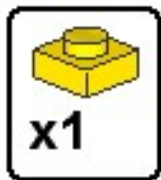

5

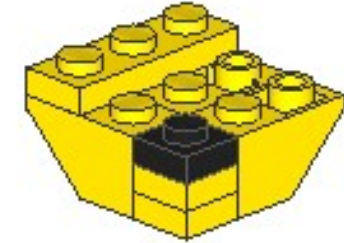
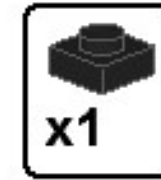

6

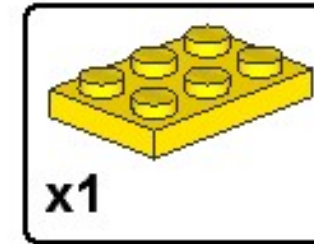

7

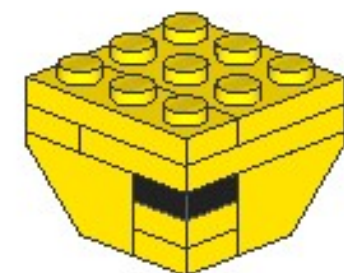
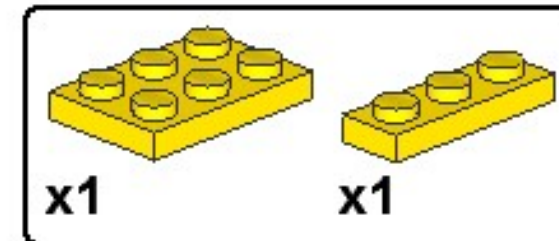

8

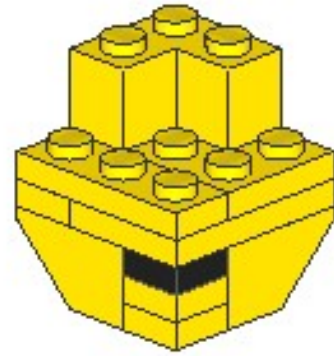
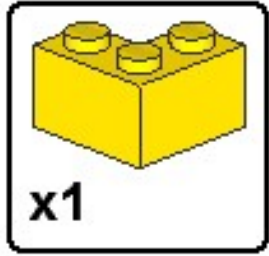

11

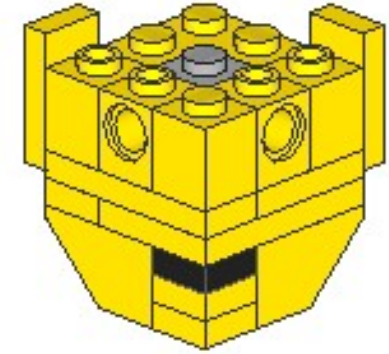
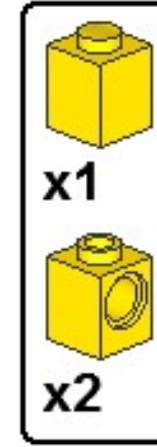

9

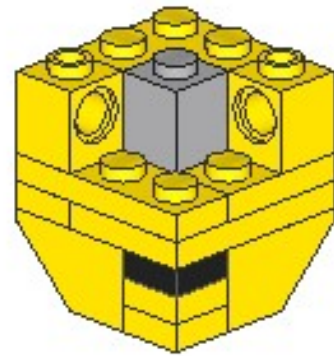
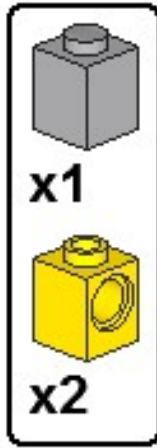

12

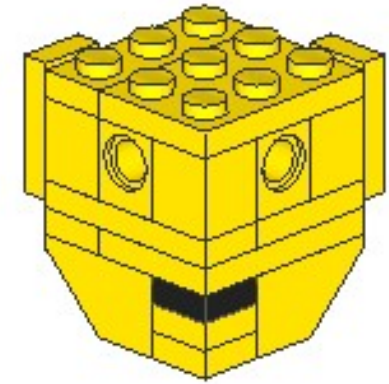
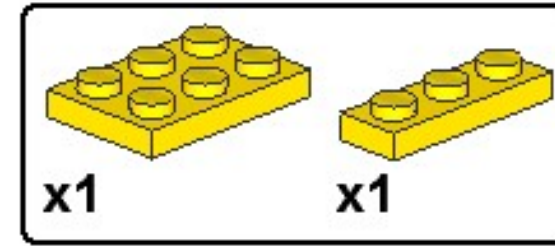

10

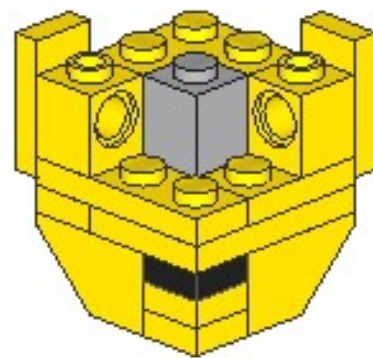
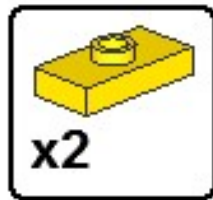

13

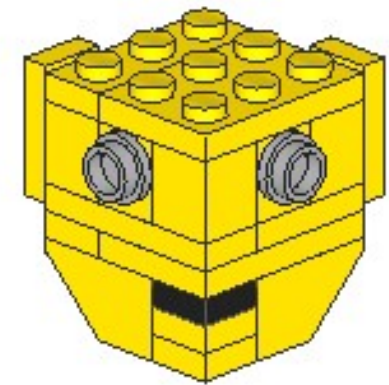
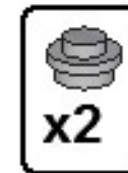

14

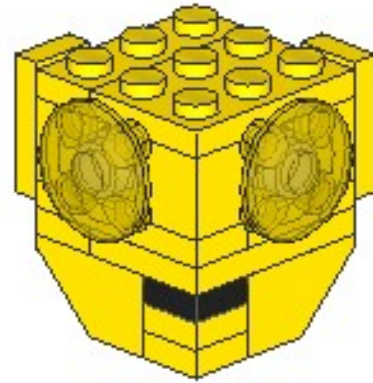

17

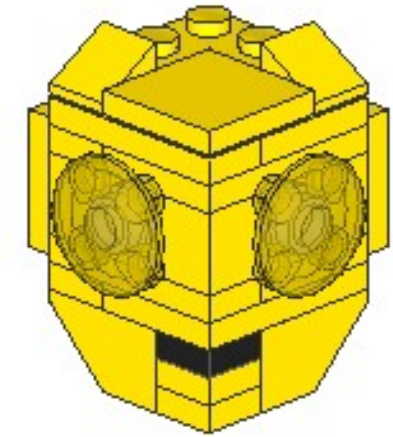
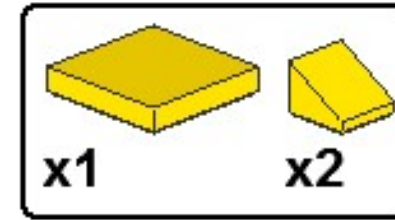

15

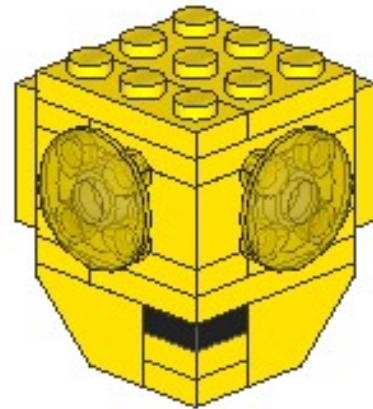
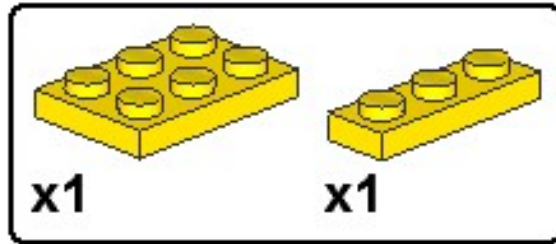

18

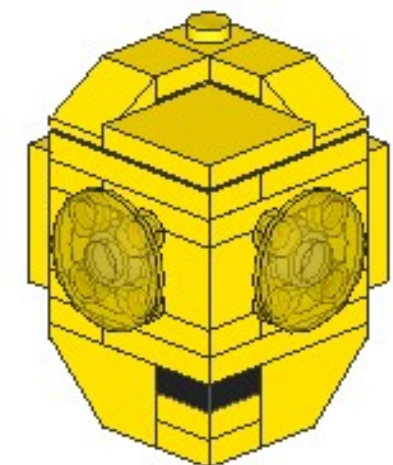
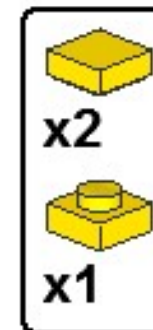

16

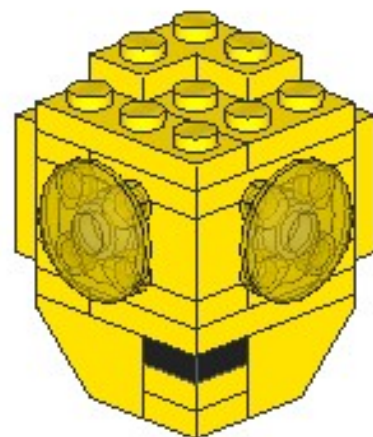
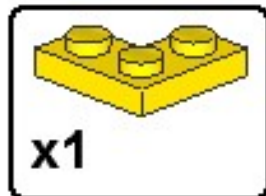



1

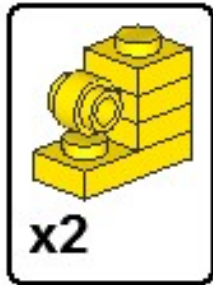

2

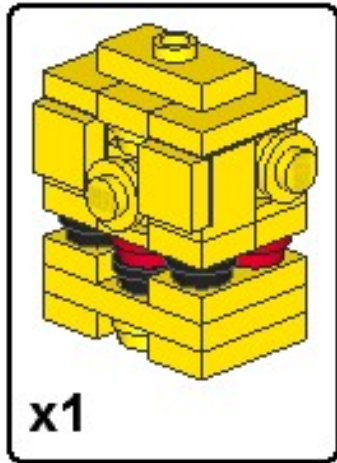

3

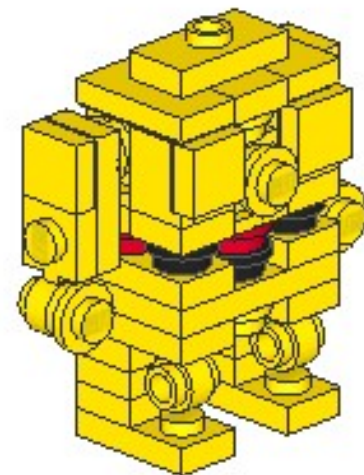
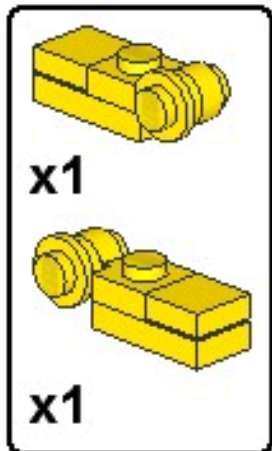

4

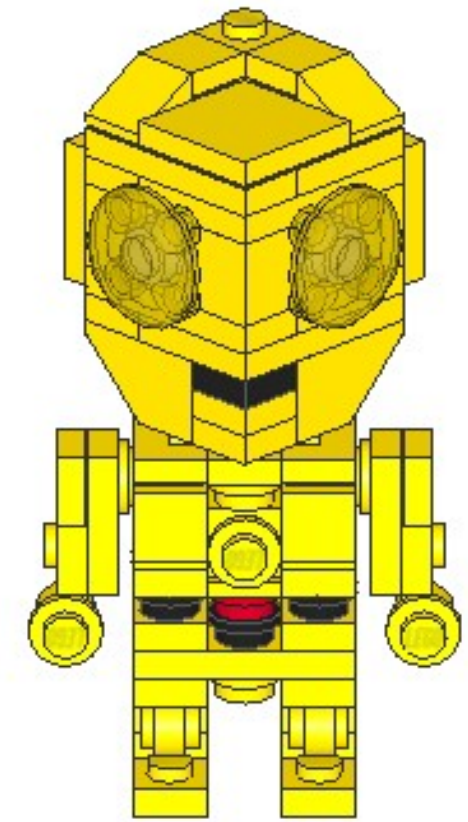
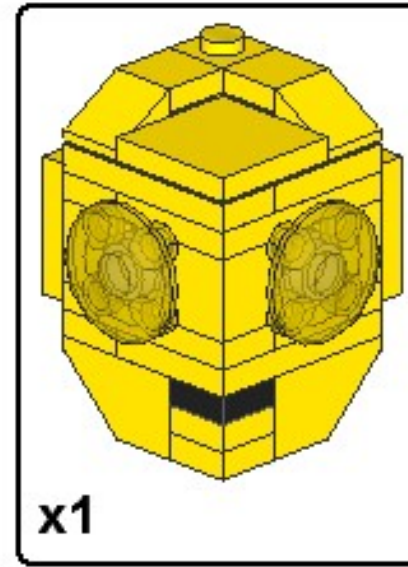

5

