

1

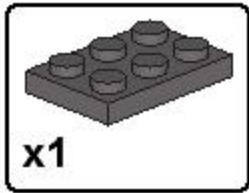

2

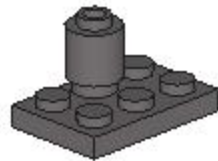
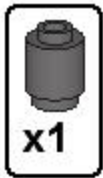

3

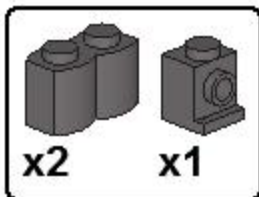

4

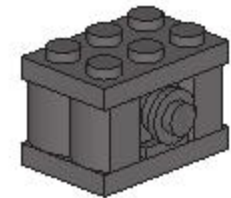
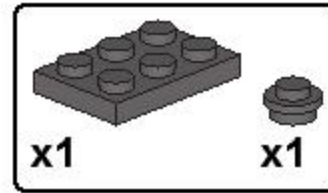

5

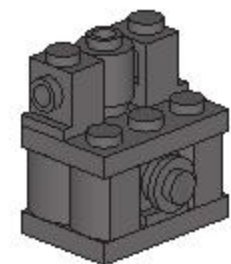
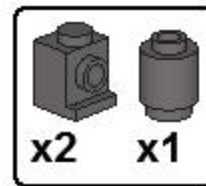

6

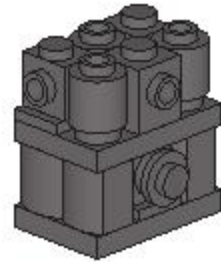
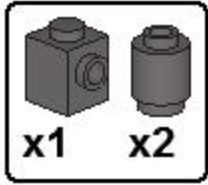

8

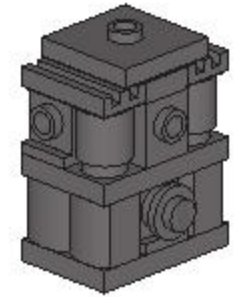
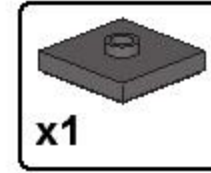

7

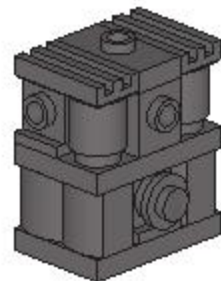
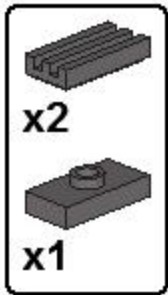

9

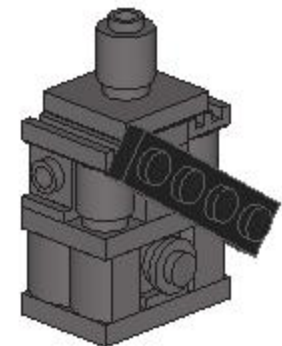
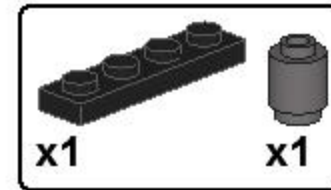

1

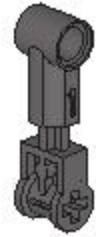
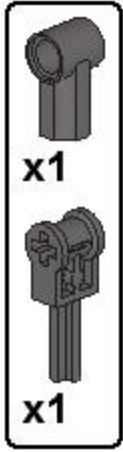

1

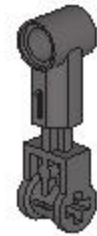
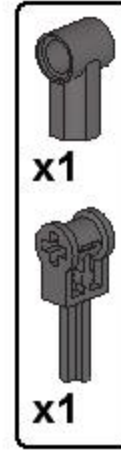

2



2



3

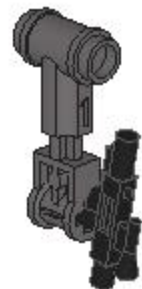

3

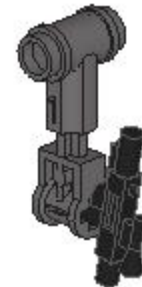
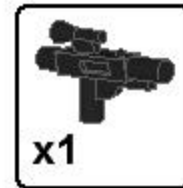

4

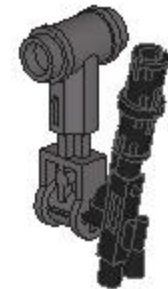
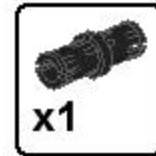

1

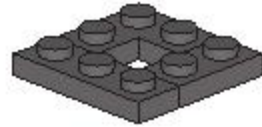
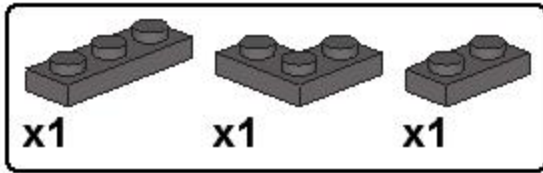

2

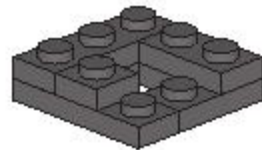
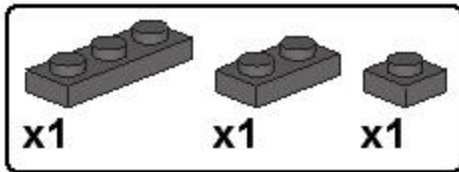

3

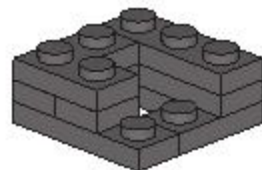
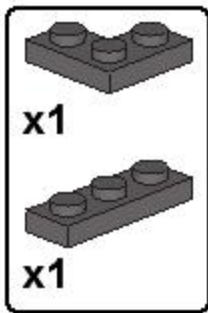

4

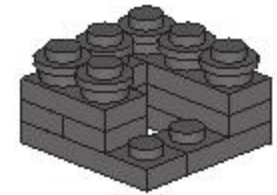

5

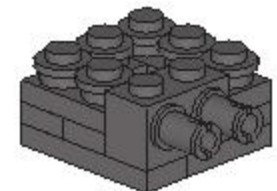
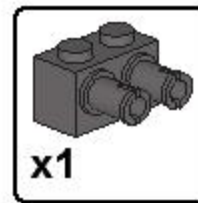

6

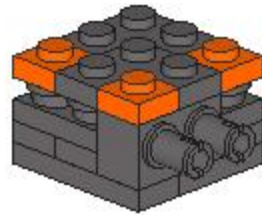
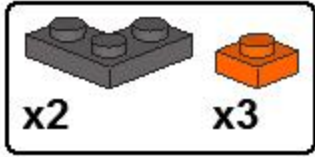

8

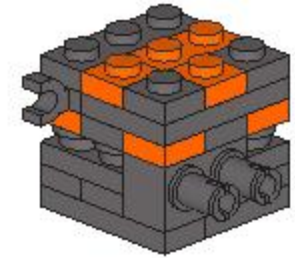
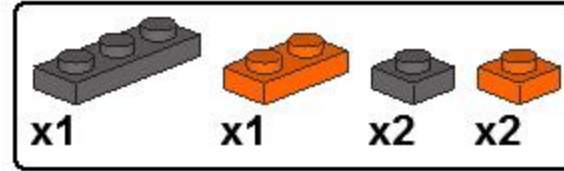

7

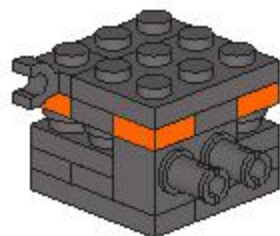
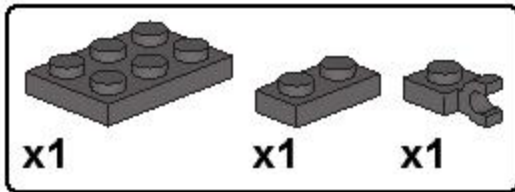

9

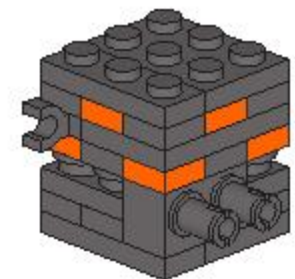
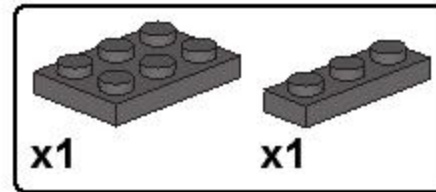

10

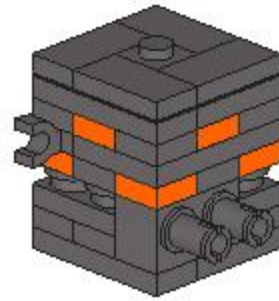
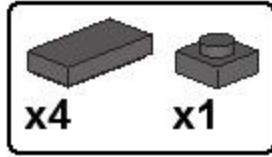

12

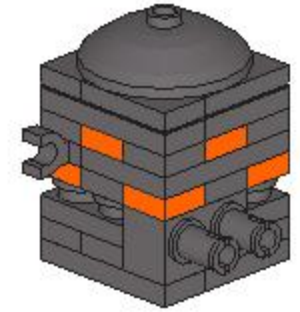
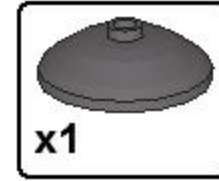

11

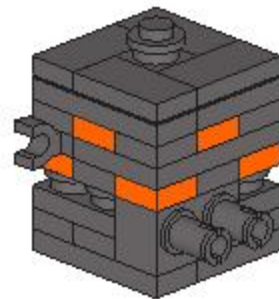

13

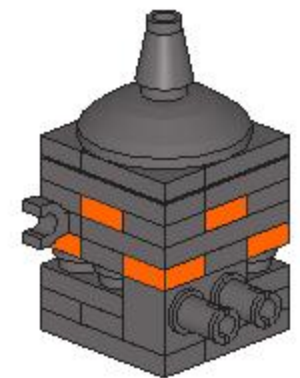
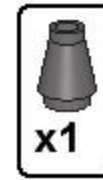



1

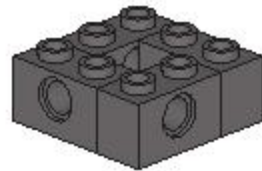

2

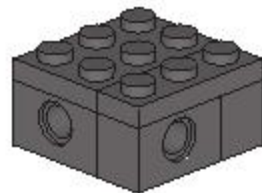
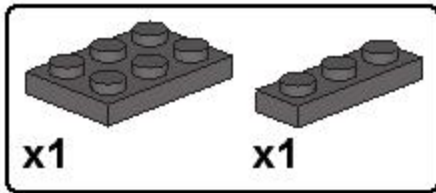

3

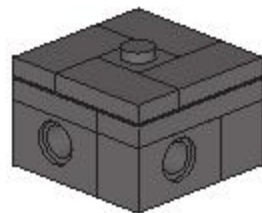
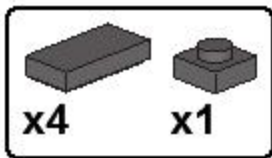

4

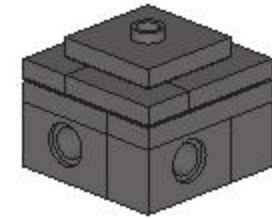
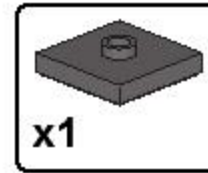

5

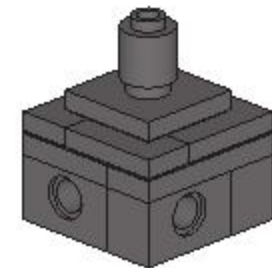
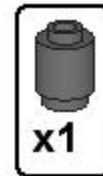

6

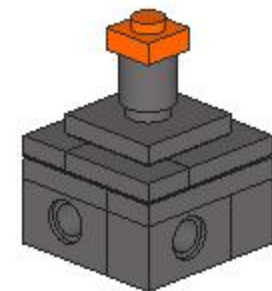
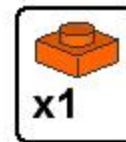



1

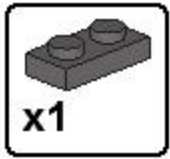

1

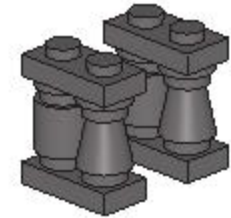
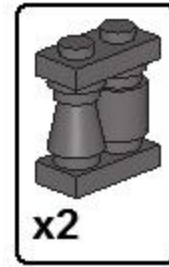

2



3



2

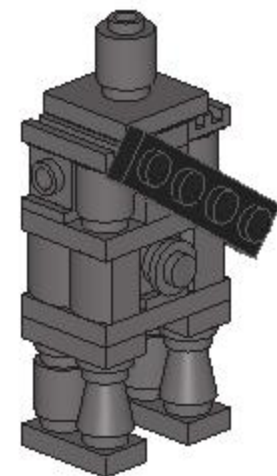
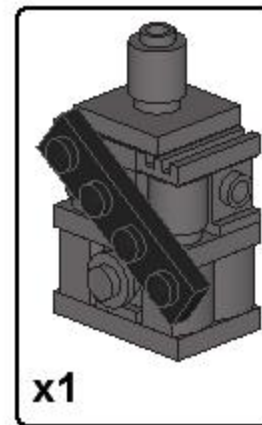

4

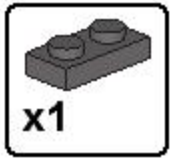

2x

3

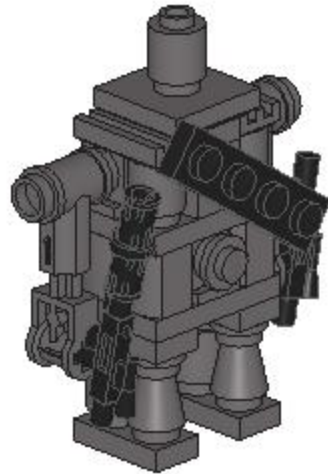
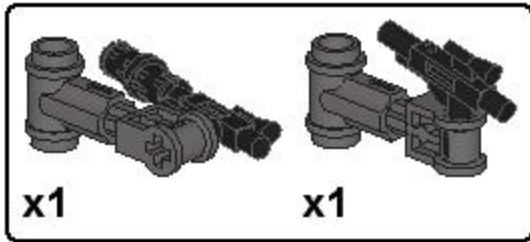

5

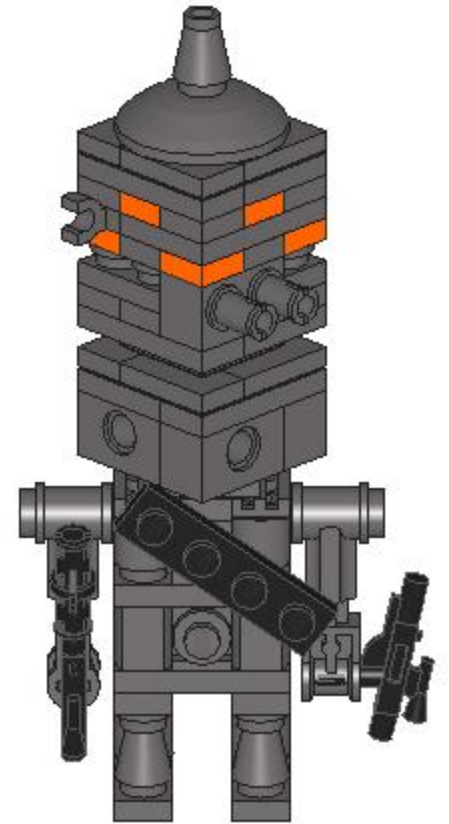
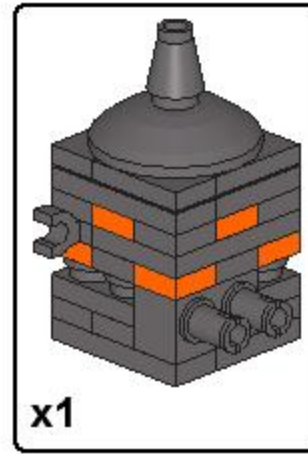

4

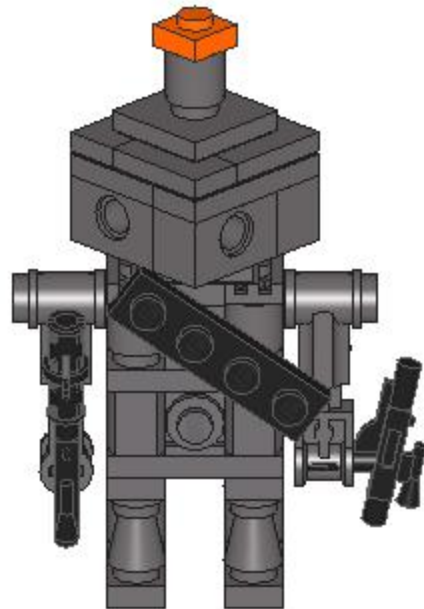
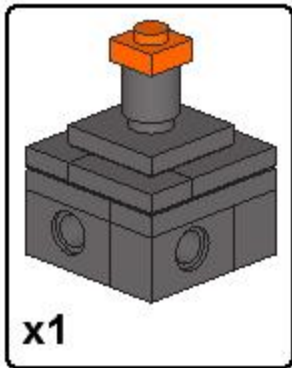

6

